

# Data Sheet



Article number: 0111013

Description: Retaining ring G 4

## Measures

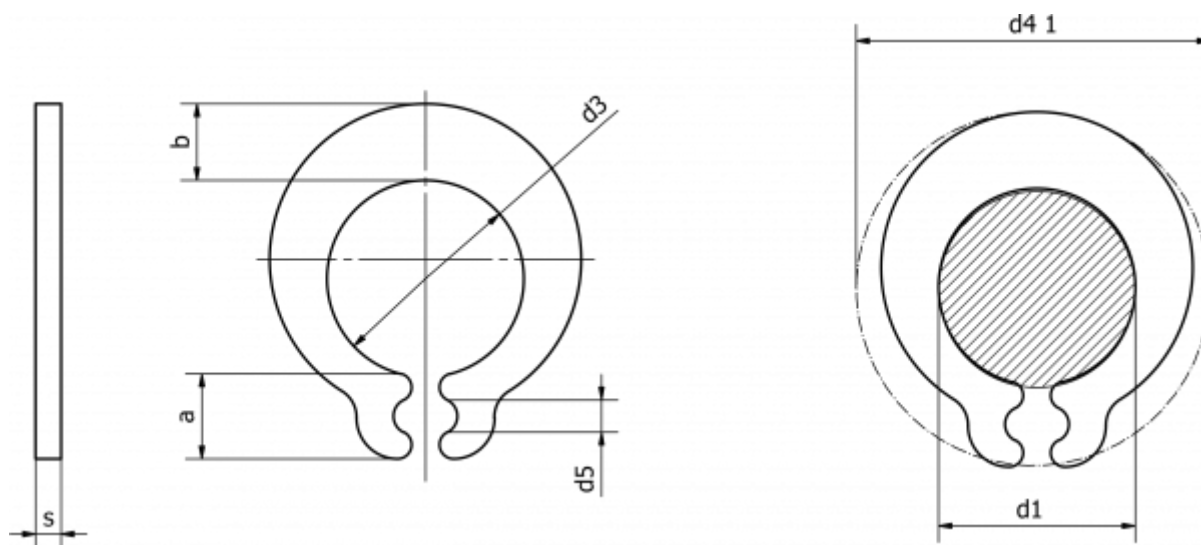

a max	= 2.7	n abl x 1000	= 125
b	= 1.8	s	= 0.80
d1	= 4.0	tol	= 0.060
d3	= 3.80	Tong	= ZGG-1
d4 1	= 9.6	Weight kg/1000	= 0.154
d5 min	= 1.2		
Description	= G 4,0		
Holding force N	= 100		